

AZZA
ONE VISION. ONE MISSION

INFERNO 310



USER MANUAL

www.azzatek.com

1. Specifications
2. Chassis Parts
3. Control Panel Functions
4. 3.5"/2.5" HDD Installation
5. Cooling System Installation
6. HURRICANE RGB LITE fan

Specifications

Model	
Model Name:	INFERNO
Model Number:	CSAZ-310
Specs	
Type:	ATX Mid-Tower
Color:	Black (exterior)/Black (interior)
Side Panel Window:	Tempered Glass with Rubber Mounts
Max CPU Cooler Height:	Up to 155mm
With Power Supply:	No
Motherboard Compatibility:	ATX, Micro ATX
Expansion	
External 5.25" Drive Bays:	1
Internal 2.5" Drive Bays:	6
Internal 3.5" Drive Bays:	2
Expansion slots:	7
Front Ports	
	2xUSB 3.0, HD Audio
Cooling System	
120mm Fan:	Front 2x120mm HURRICANE RGB LITE fan, 1x120mm black rear fan
Physical Specs	
Dimensions(HxWxD)	480X205X475mm / 18.9X8.1X18.7 inch
Weight	N.W.: 6.7 kg / G.W.: 8.3 kg
Features	
RGB Light Effects	2xHURRICANE RGB LITE fans, RGB logo plate, RGB front panel. All RGB light effects controlled by external button.
Max VGA card length	Support up to 380mm long VGA card
Tempered Glass Side Window	High-quality tempered glass with rubber mounted side window allows for clear visuals to inner components.
Available Fan Ports	3x120mm/2x140mm fan ports on the top 2x120mm/2x140mm fan ports in the front (2x120mm RGB LED fans included) 1x120mm/1x140mm fan port in the rear (120mm fan included)
Water Cooling	Supports radiator up to 360mm on top/280mm in front
Isolated Chamber	Power supply is housed inside its own isolated chamber, preventing its heat from affecting other components.
Easy installation Cooler	A pre-cut hole for easy installation of CPU cooler, eliminating the need to remove the motherboard



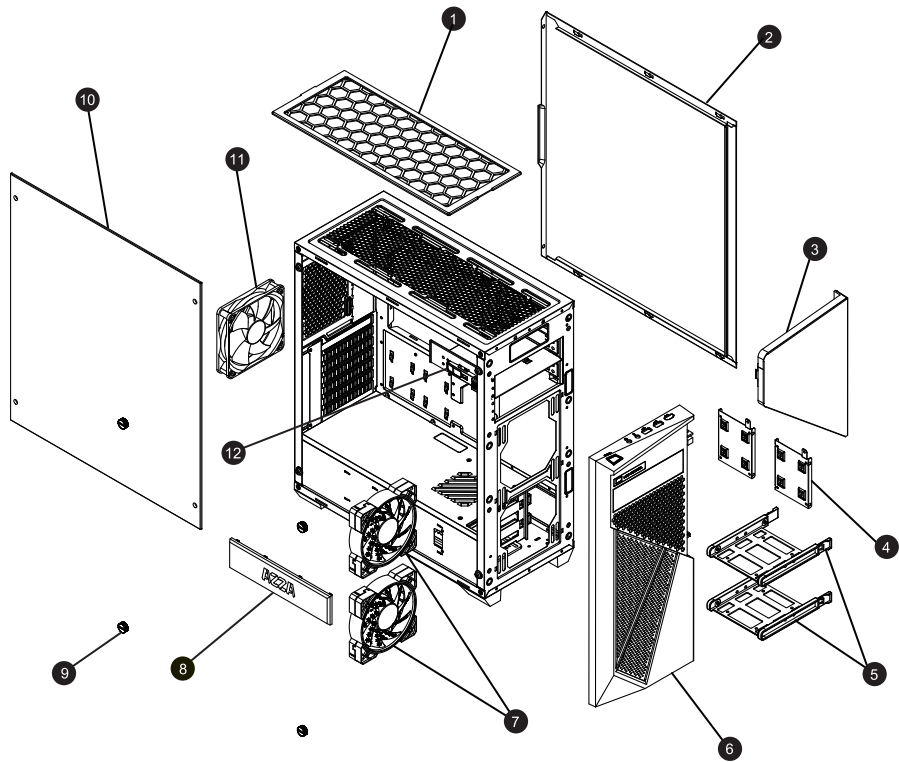



Chassis parts

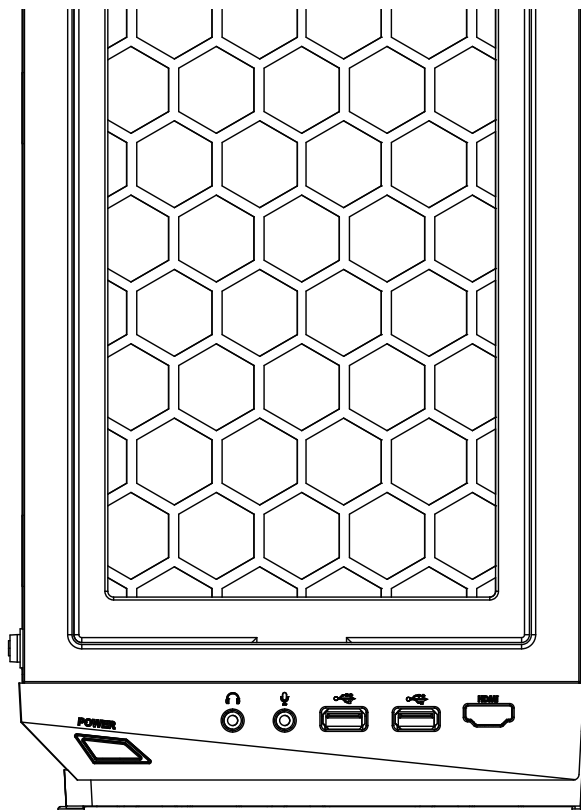

1	Dust filter
2	Right side panel
3	Door
4	SSD brackets
5	HDD/SSD tray
6	Front bezel
7	RGB fan x2
8	Logo plate with back RGB lights
9	Hand screw
10	Left side panel
11	120mm black fan x1
12	ODD bay

Control panel functions



	Power		Mic
	USB3.0(Blue)		Audio
	USB3.0(Blue)		(Option)

3.5" / 2.5" HDD Installation

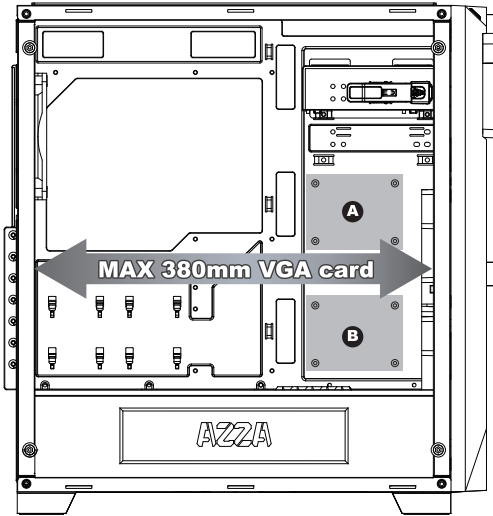

▪ Supports up to 380mm long VGA cards.



or

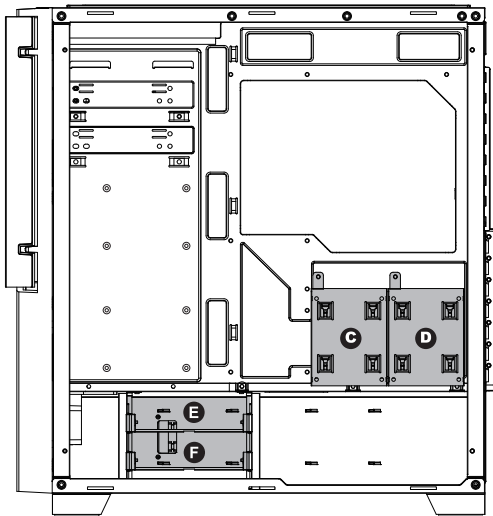
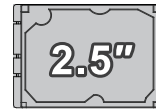

▪ Two mounting holes support 2.5" devices. (A B)

▪ Two brackets support 2.5" devices. (C D)

▪ Two multifunctional trays support 3.5" HDD or 2.5" SSD. (E F)

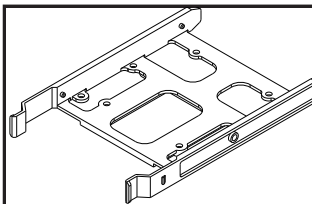

Multifunctional bracket.

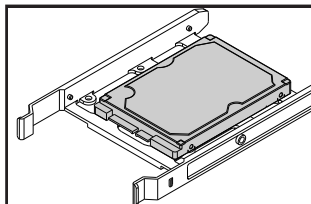

Secure 2.5" SSD / HDD with screws.

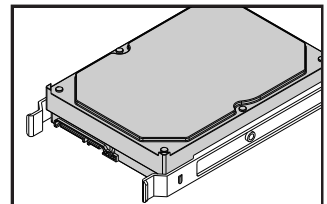

Secure 3.5" HDD with screws.

Cooling System Installation

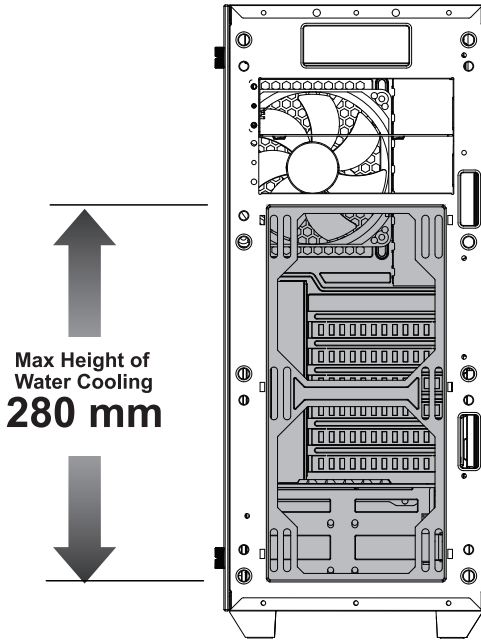

Front

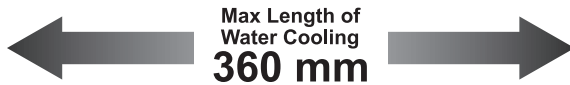
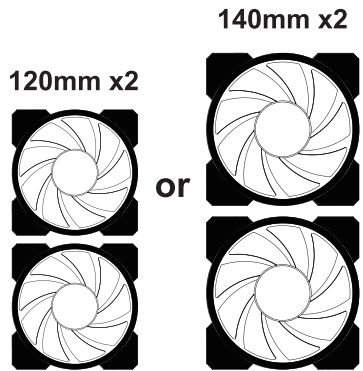

Top

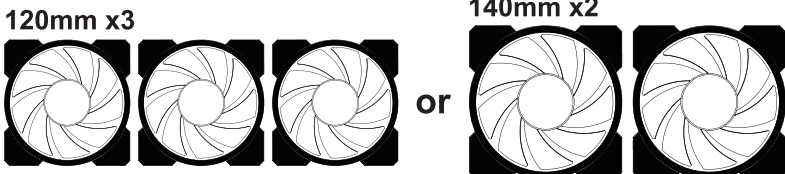
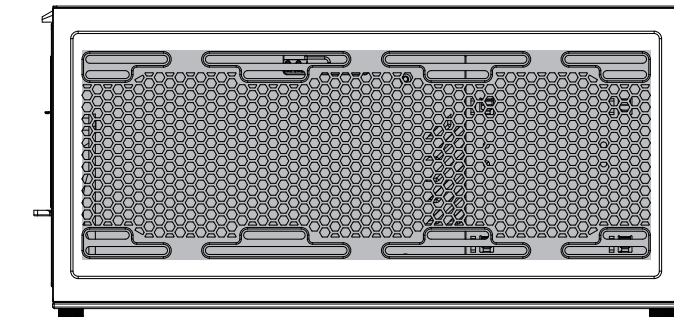

Patented Design

VORTEX AIR (Patented)

To help improve cooling performance, our patented Shark Teeth design helps channel the air into a concentrated stream for more powerful air flow.

SILENCE (Patented)

Special grooves carved into the fan blades help reduce noise levels up to ten percent!

SYNC RGB (Patented)

By plugging the Hurricane RGB fan into a RGB-compatible motherboard, lighting and fan speed can be controlled directly without the need for additional hardware.

CYLINDRICAL LIGHTNING (Patented)

More light is better. With a frame made of acrylic material, the RGB lighting is spread all throughout the fan's frame, giving a clean, uniform look.

Model Name	HURRICANE RGB LITE
Model Number	FNAZ-12RGB-B-002
	FNAZ-12RGB-W-002
Rated Voltage	12V
Fan Speed	1500 RPM
Max. Air Pressure	1.26 mm-H ₂ O
Max. Air Flow	47RPM
Max. Noise Level	28.7dB(A)
Bearing Type	Sleeve Bearing
Life expectation	60,000 hrs,40°C
Connector	3-PIN
	4-PIN RGB: Male & Female
Fan Dimension	120x120x25mm
Color	7 Color with RF remote 16.8M with LUMI

HURRICANE RGB LITE fan

- The first RGB fan is to be connected to the RGB LED control board in the chassis, while the rest of them can be daisy chained to the first one with their own male and female plugs.

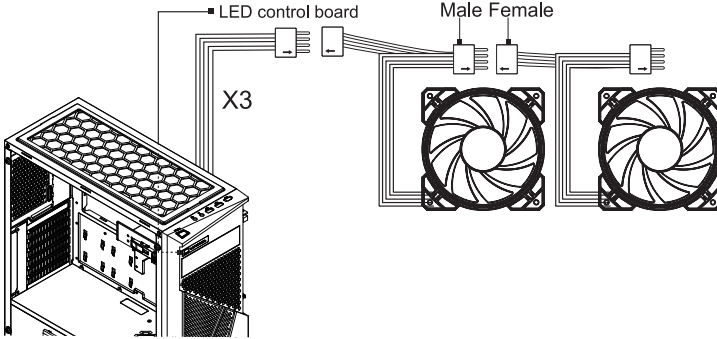

Two versions RGB control board, please follow the below instructions depends on your chassis.

VERSION(A)

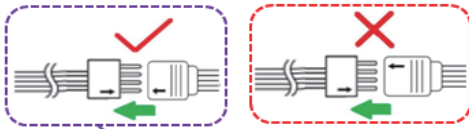

VERSION(B)

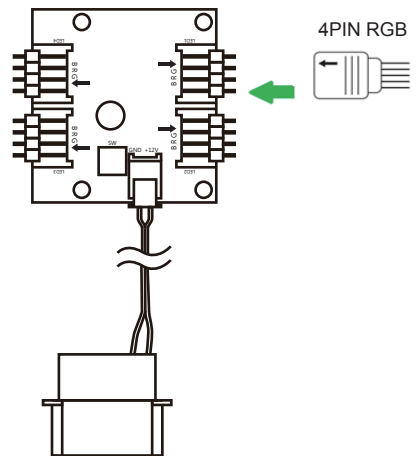
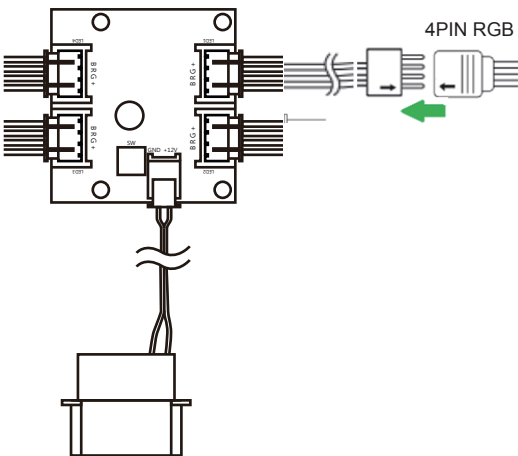
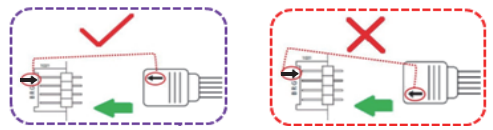

HURRICANE RGB LITE fan

- If you have a RGB-compatible motherboard, then you can connect the Hurricane fan's 4-pin connector directly into your motherboard. You can then adjust fan colors using your native fan control software.

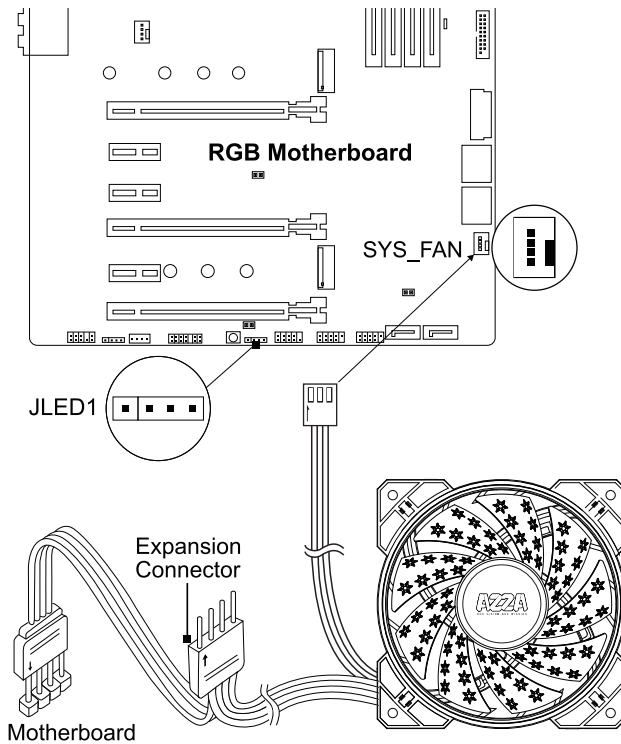

AZZA
ONE VISION. ONE MISSION