

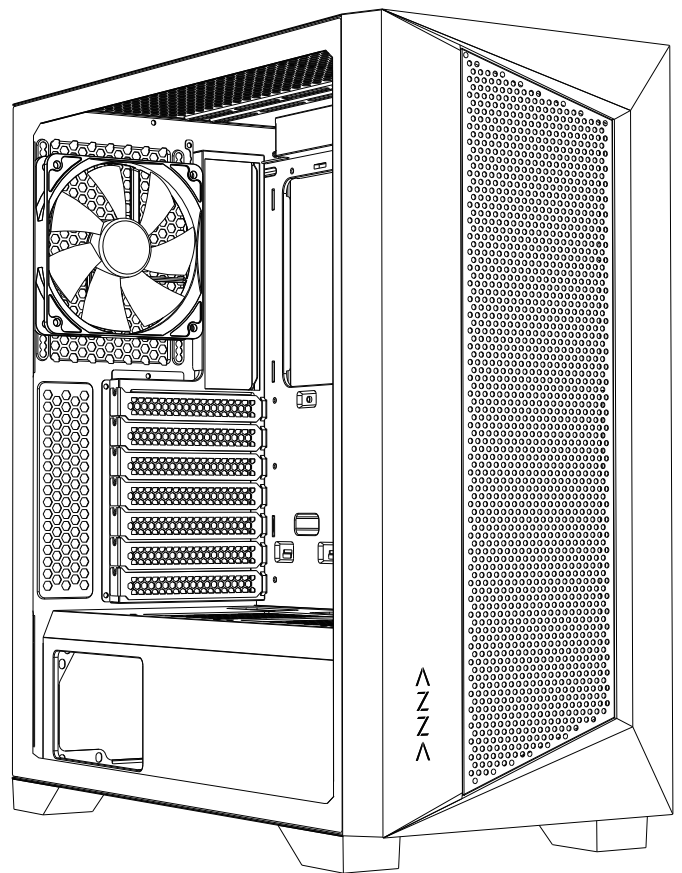

CSAZ-460A

CSAZ-460B

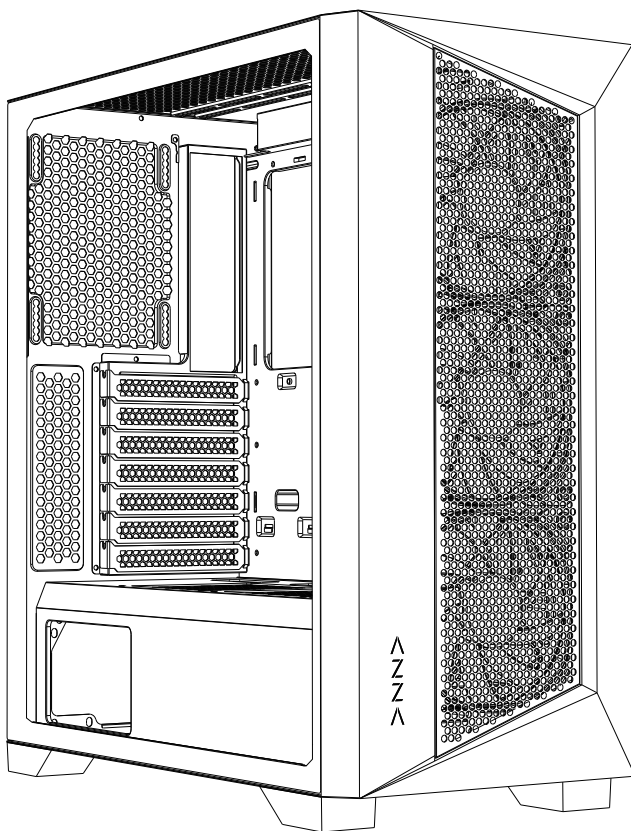

Octane

USER MANUAL

1. Specifications
2. Chassis Parts
3. Control Panel Functions
4. 3.5"/2.5" HDD/SSD Installation
5. Cooling System Installation
6. ARGB Control Board
7. ARGB Control Modes Switching

Specifications

Model	
Model Name:	Octane
Model Number:	CSAZ-460A/CSAZ-460B
Specifications	
Type:	ATX Mid Tower
Color:	Black/Black(interior), White/White(interior)
Side Panel Window:	Left Side panel: Slidable tempered glass panel
Max CPU Cooler Height:	UP to 165mm
Max Video Card Length:	Up to 360mm long video card
Power Supply:	Not Included
Motherboard Compatibility:	<270mm E-ATX · ATX · Micro ATX · ITX
Expansion	
External 5.25" Drive Bays:	0
Internal 2.5" Drive Bays:	Up to 4
Internal 3.5" Drive Bays:	Up to 2
Expansion Slots:	7
Top Ports:	Power button, reset button, Led button, HD Audio, USB 3.0 x 1, USB2.0x2
Physical Specifications	
Case Dimension (HxWxD)	470x215x443/18.5x8.5x17.4 inches
Weight:	6.4kg /14.1lbs
Features	
Tempered Glass Sides Window:	High-quality tempered glass side window allows for clear visuals to inner components
Addressable RGB Light Effects:	CSAZ-460A: All ARGB light synchronize devices connect to the ARGB control board. CSAZ-460B: Addressable RGB light strip in the front and all ARGB light synchronize devices make connections. Allowing the LED button to directly control the ARGB lighting, or switched to be controlled by the motherboard synchronize software..
Available Fan Ports:	3x120mm or 3x140mm Fan ports in the front(CSAZ-460A: 3x120mm ARGB fan included) 3x120mm or 2x140mm Fan ports on the top 1x120mm Fan port in the rear(CSAZ-460B: 1x120mm black fan included)
Water Cooling:	Supports radiators up to 280/360mm in the Front Supports radiators up to 240mm in the Top
Dust Filters:	Removable (magnetic) dustproof net on the top, iron net on bottom of chassis. CSAZ-460B: LED light guide mesh on the front.
Power Supply Support:	Bottom mounted ATX Power Supply

CSAZ-460A

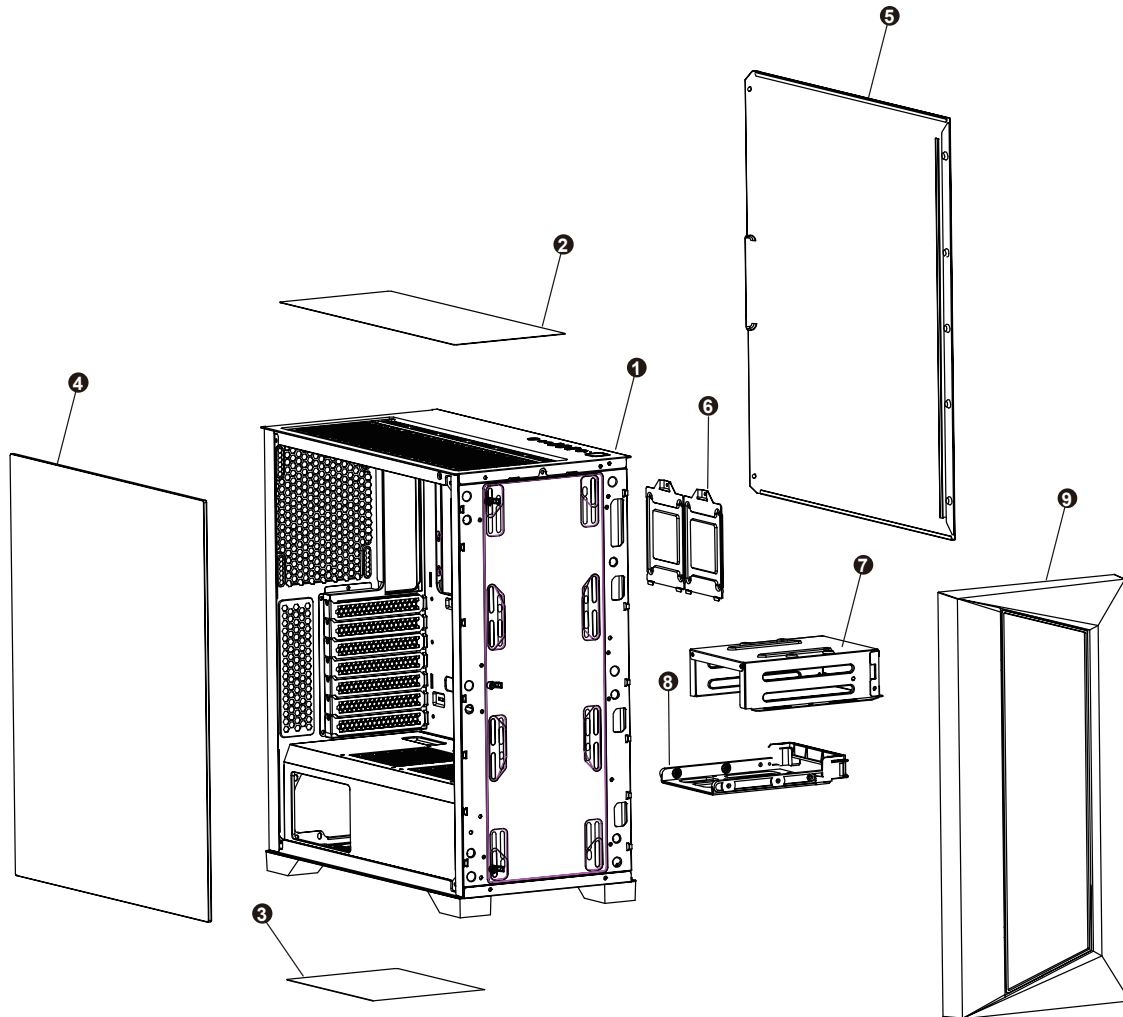

1	Chassis
2	Removable magnetic mesh
3	Steel dust filter
4	Sliding tempered glass panel
5	Metal side panel
6	2.5" SSD tray x 2
7	Hard disk cage
8	3.5" HDD/ 2.5" SSD brackets
9	Front panel



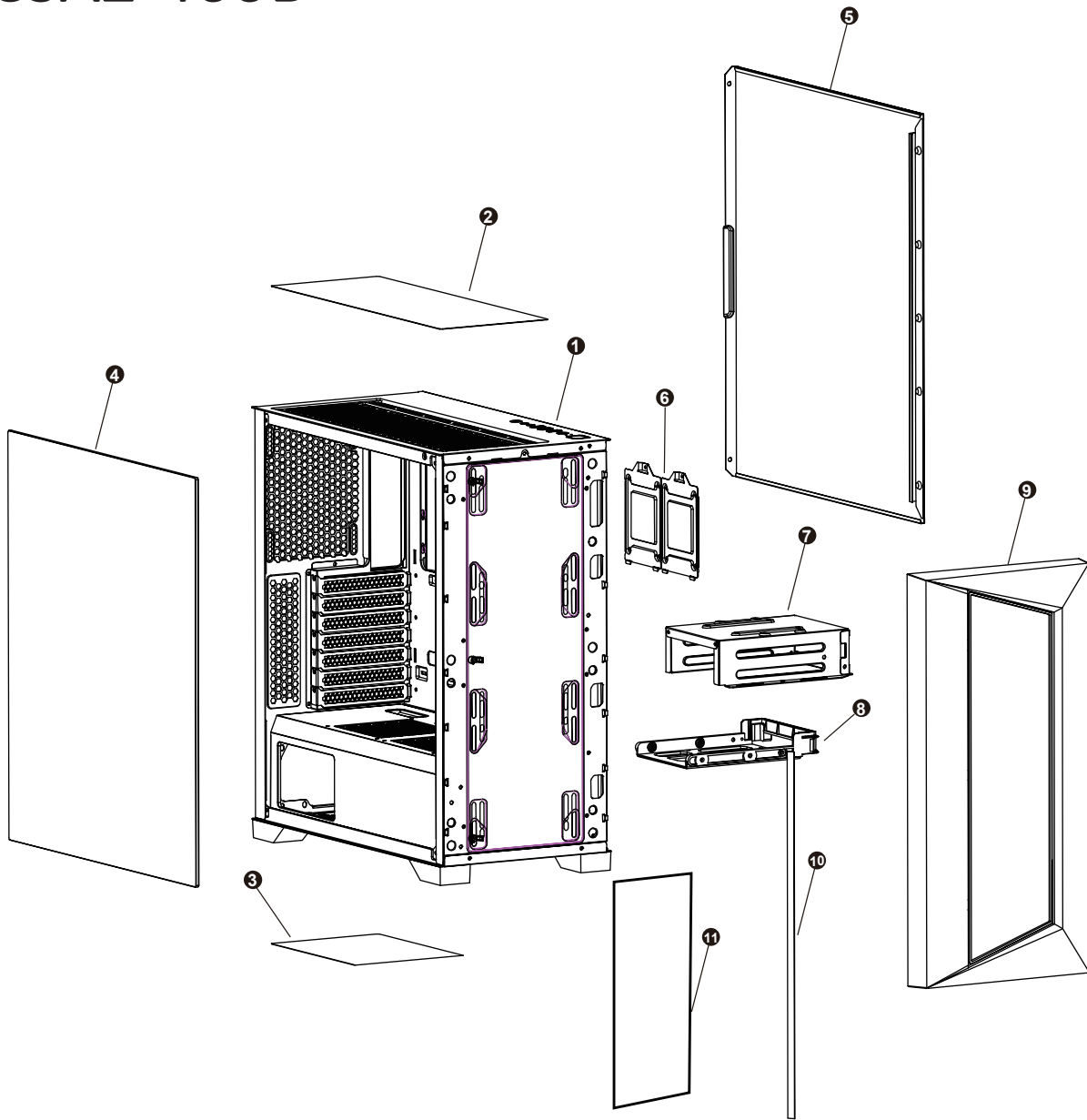

CSAZ-460B



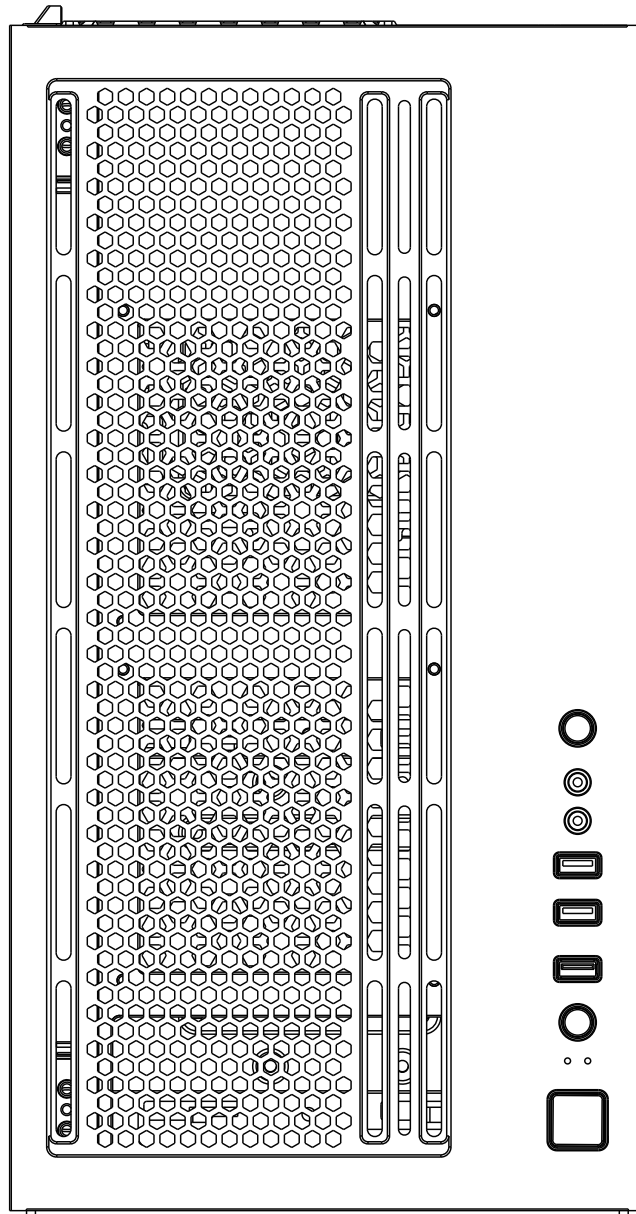

1	Chassis
2	Removable magnetic mesh
3	Steel dust filter
4	Sliding tempered glass panel
5	Metal side panel
6	2.5" SSD tray x 2
7	Hard disk cage
8	3.5" HDD/ 2.5" SSD brackets
9	Front panel
10	Addressable RGB strip
11	Led light guide mesh

Control Panel Functions



	POWER
	RESET
	LED
	Audio

	USB 3.0 (Blue)
	USB 2.0 (Black)
	Mic

3.5" / 2.5" HDD/SSD Installation

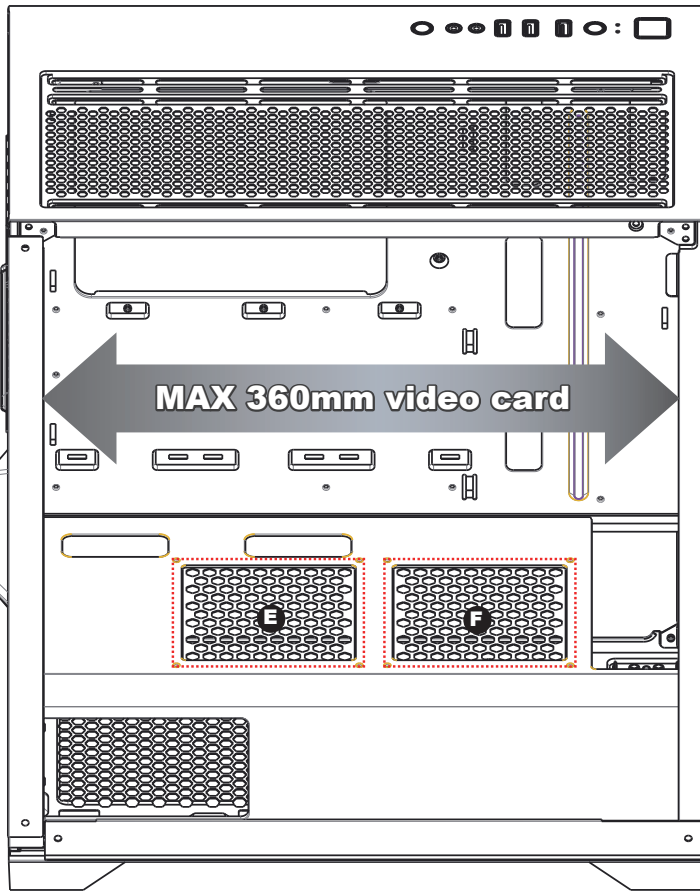

- Supports up to 360mm long video cards.
- Supports up to 120mm fan x2 (**E** **F**)



or

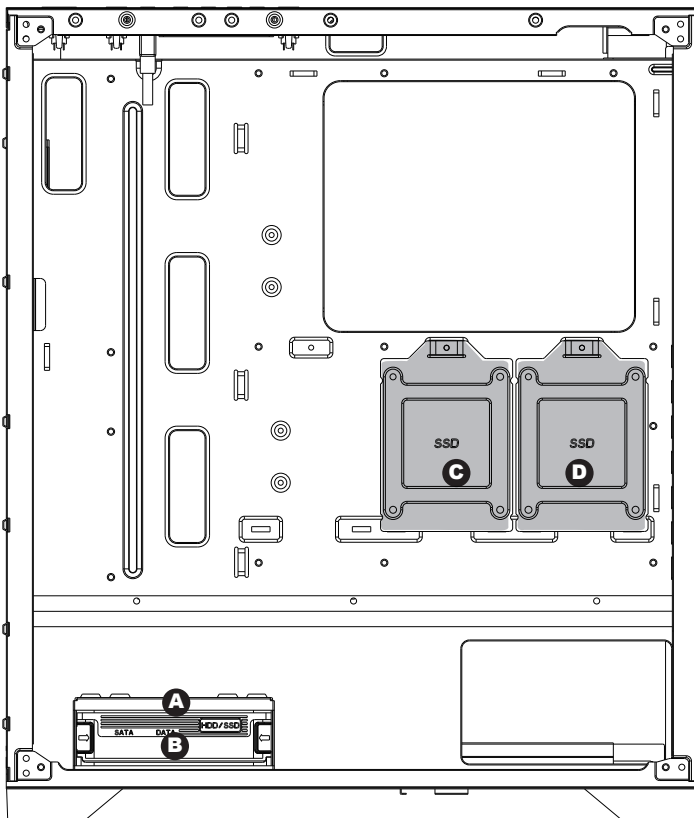

- Multifunctional hard disk cage support
3.5" HDD or 2.5" SSD x 1 (**A**)
- Multifunctional hard disk bracket support
3.5" HDD or 2.5" SSD x 1 (**B**)
- 2.5" SSD metal tray support 2.5" SSD x 2
(**C** **D**)

Front

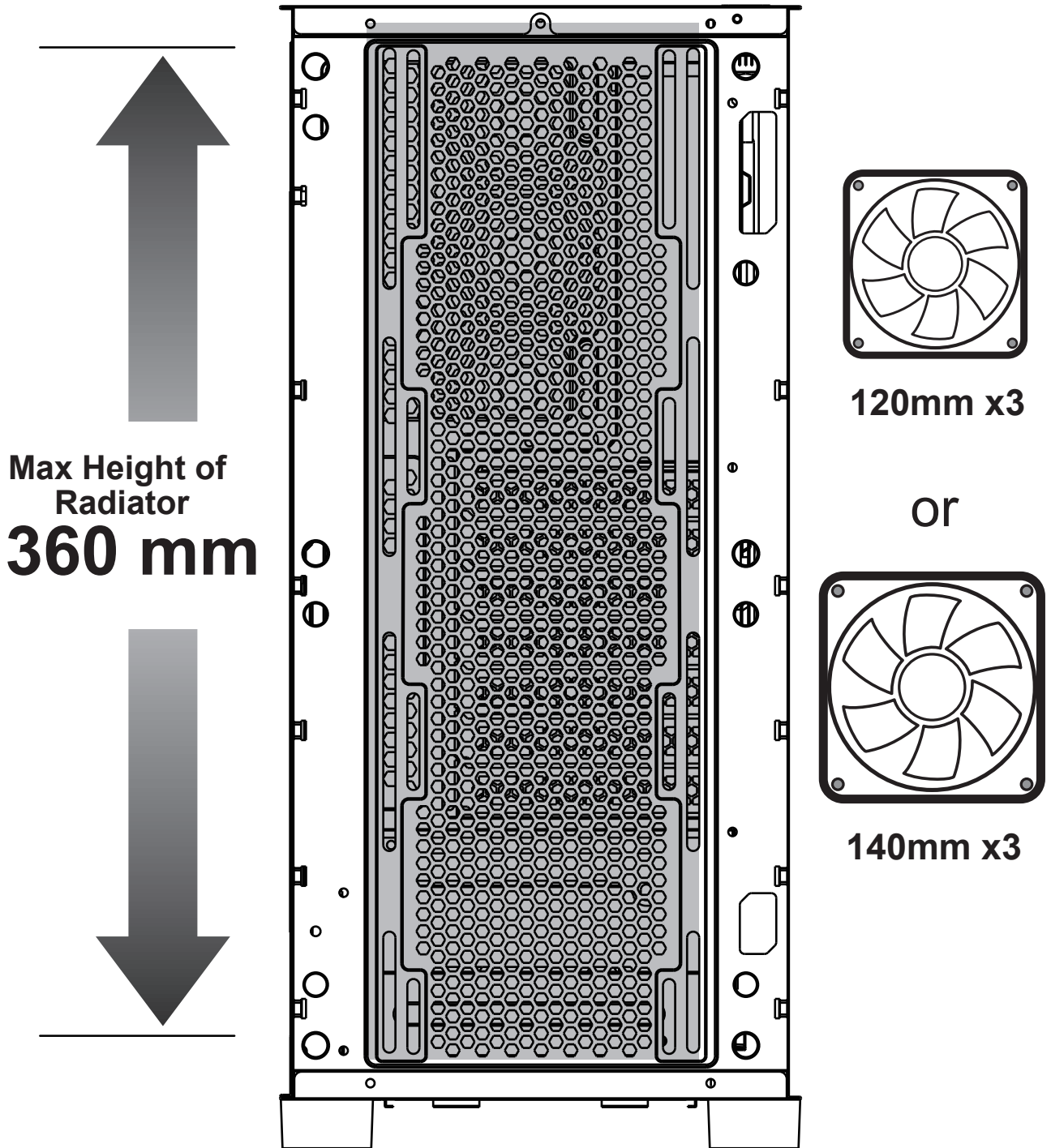

Rear

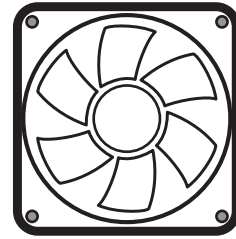
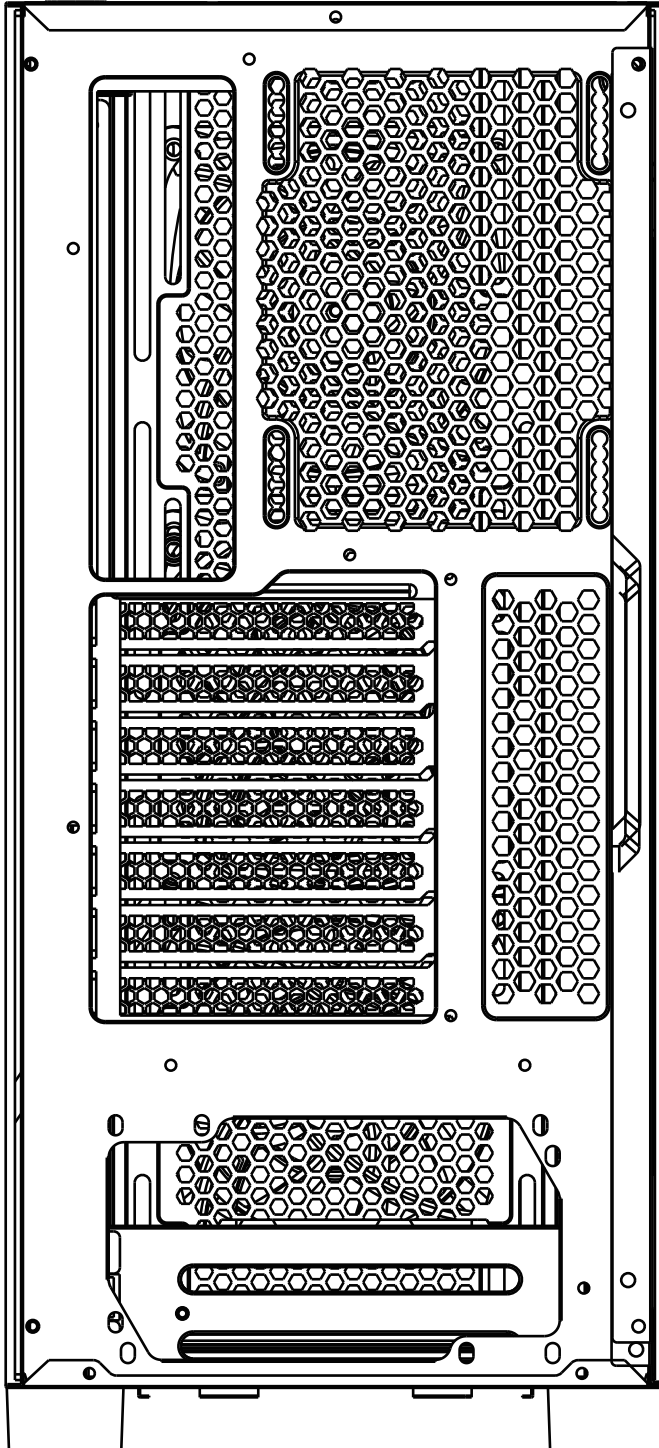

120mm x1

Top

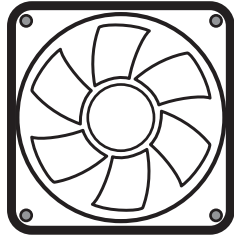

120mm x3

or

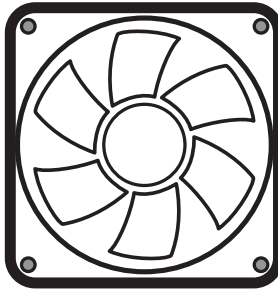

140mm x2

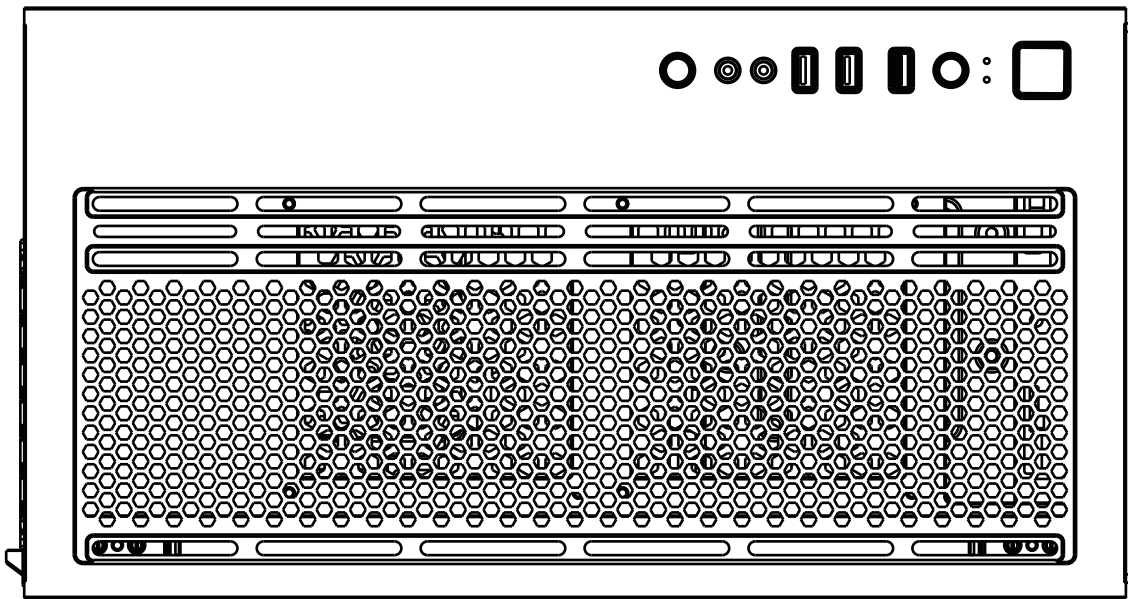

Max Length of
Radiator
240 mm

CSAZ-460A

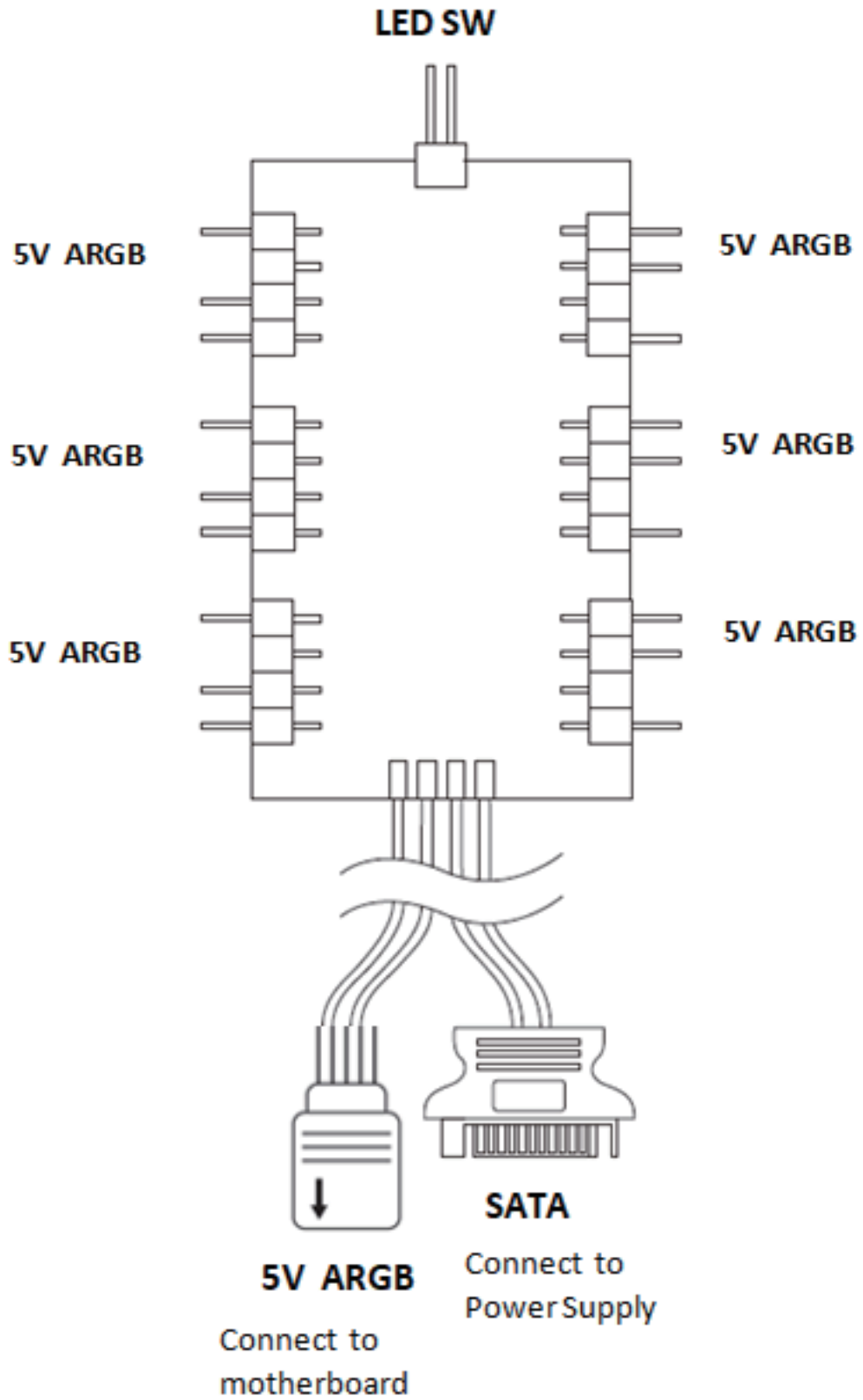

CSAZ-460A

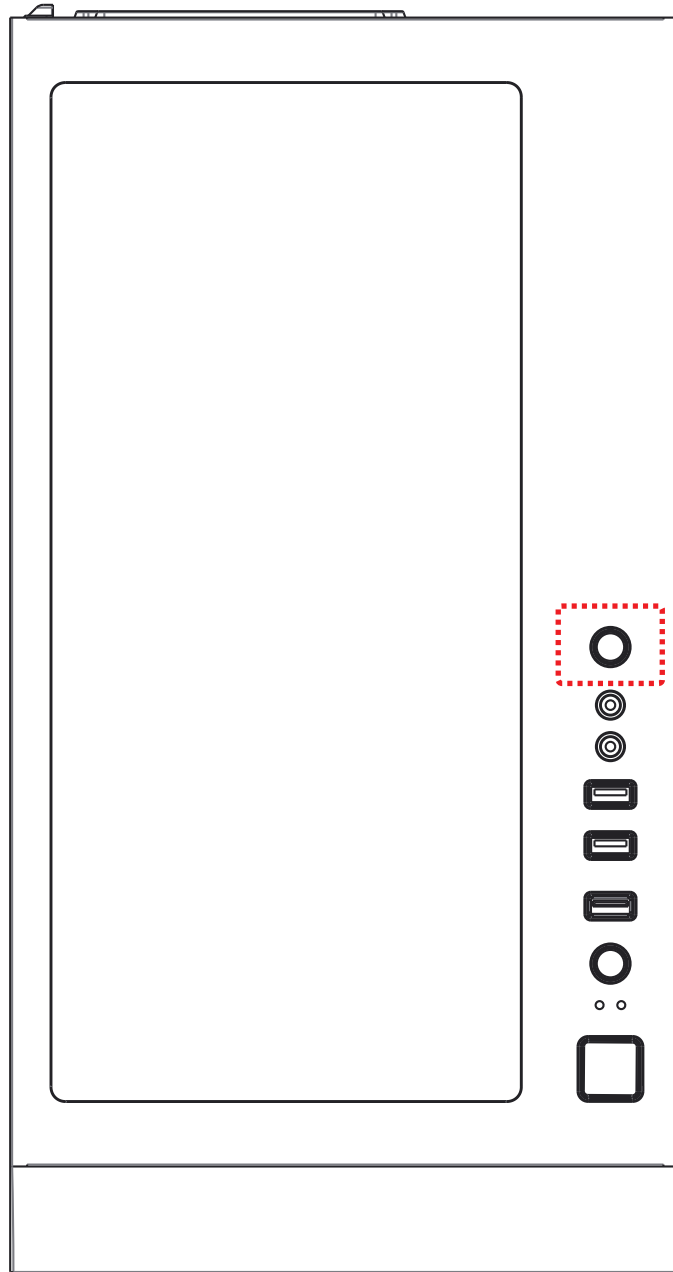

※ Press the LED button to cycle through different RGB lighting modes, controlled by the LED button though the ARGB control board.

※ Hold the LED button for 3 seconds to switch the RGB control function between motherboard RGB software and LED button.

CSAZ-460B

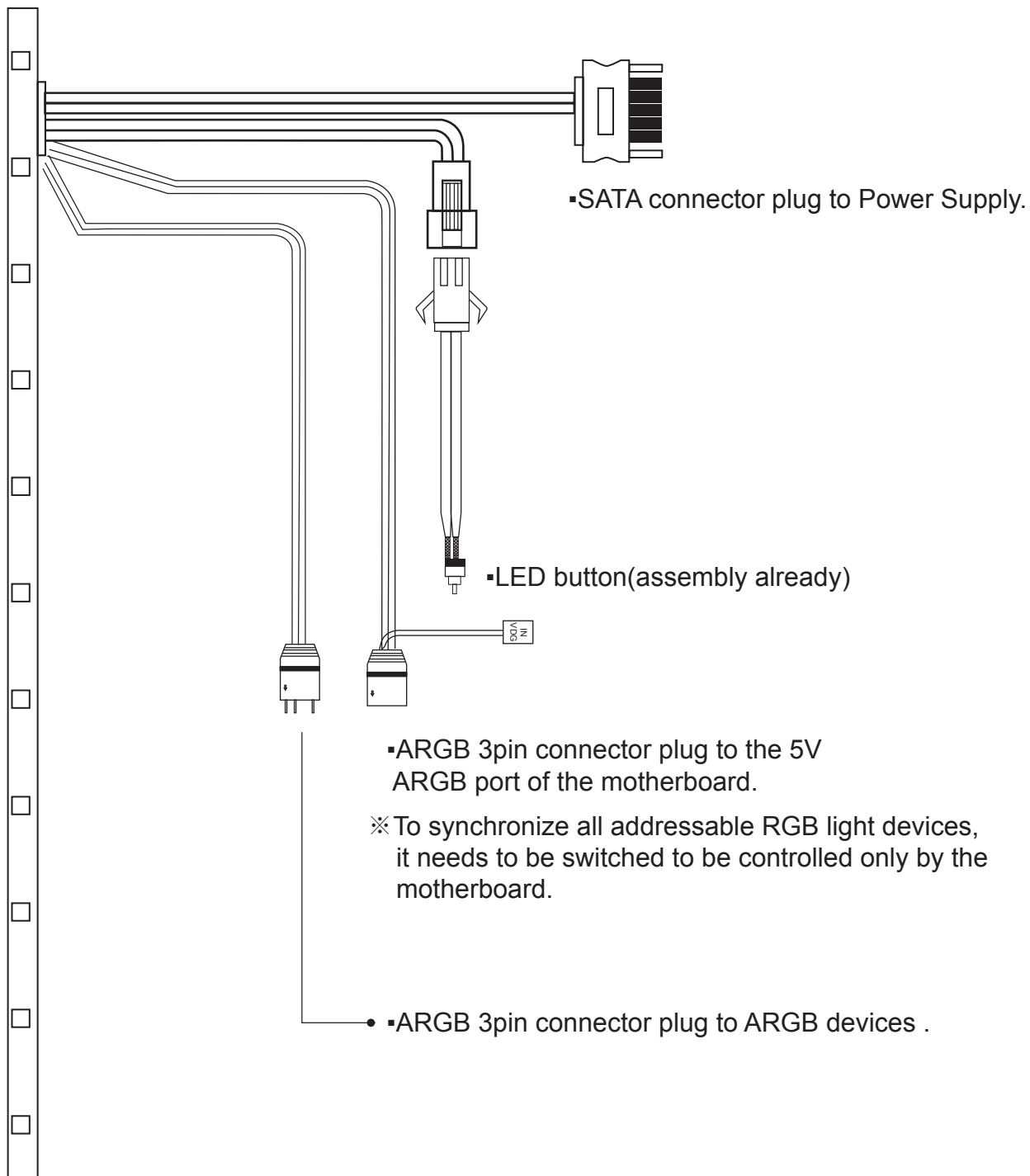

CSAZ-460B

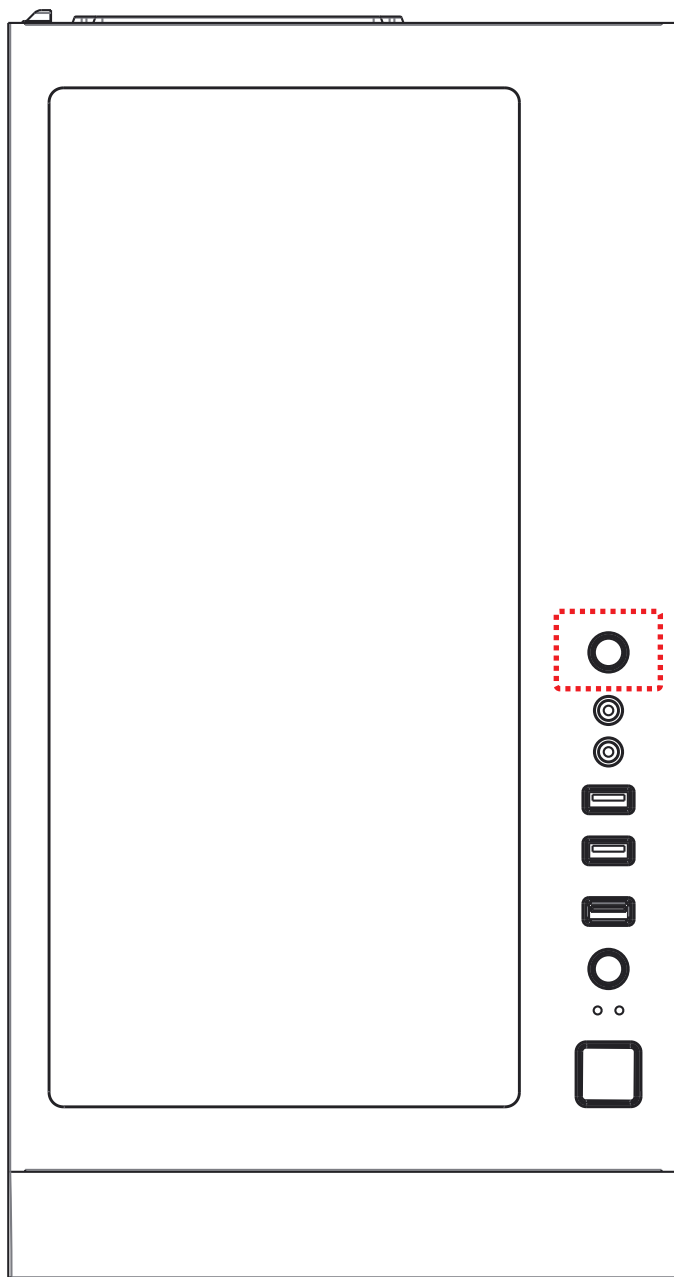

Hold the LED button for 3 seconds to switch :

Switch the RGB mode by LED button(Default)

3 seconds

3 seconds

Switch the RGB control function to the motherboard software

Turn off the light

3 seconds

※ Press the LED button to cycle through different RGB lighting modes, controlled by the LED button through the ARGB control board.

※ Hold the LED button for 3 seconds to switch the RGB control function between motherboard RGB software and LED button, or turn off the light.

